

IPANDEE

Installation And Operation Manual



MPPT

Acid

Li

SOLAR CHARGE CONTROLLER

EXPLORER-T

EN

DIMENSIONS

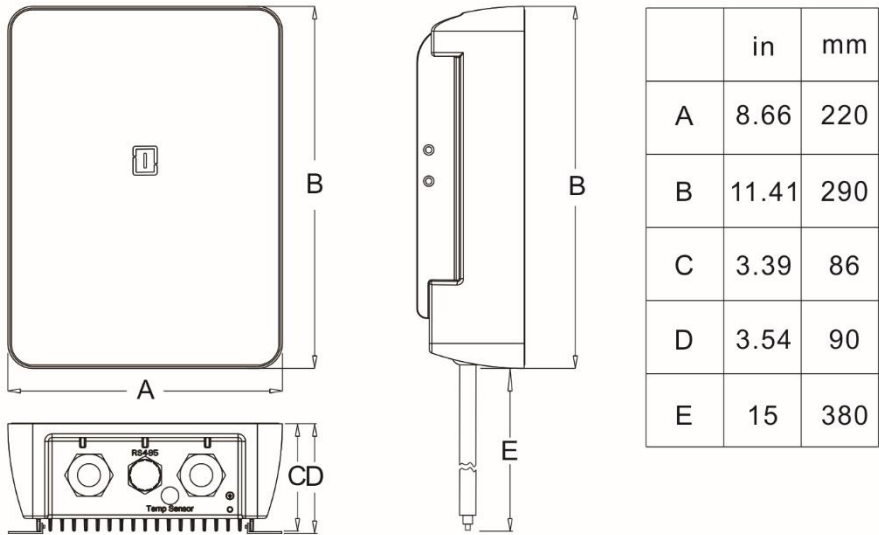

SPECIFICATION SUMMARY

Type	ET4850	ET4860
Nominal Battery Voltage	12/24/48V	12/24/48V
Max.PV Open-Circuit Voltage*	150V	150V
Nominal Max.Input Power**	650/1300/2600W	780/1560/3120W
Max.Battery Charging Current	50A	60A

*Array voltage should never exceed this limit.

**These power limits refer to the maximum wattage the MPPT can manage. Higher power arrays can be used without damaging the controller.

TABLE OF CONCENTS

1.0 Important Safely Instructions	1
2.0 General Information	4
2.1 Features	4
2.2 Attached Accessories	4
2.3 Optional Accessories	5
3.0 Installation Instructions	6
3.1 General Installation Notes	6
3.2 Mounting	7
4.0 Operation	9
4.1 Max Power Point Tracking Technology	9
4.2 Battery Charging	10
4.3 Electrical structure and function description	12
4.4 Status Indications	12
4.5 operate	13
5.0 Trouble Shooting	14
6.0 Technical Specifications	15
Appendix	17

1.0 IMPORTANT SAFETY INSTRUCTIONS

SAVE THESE INSTRUCTIONS.

This manual contains important safety, installation, and operating for the MPPT solar controller.

The following symbols are used throughout this manual to indicate potentially dangerous conditions or mark important safety instructions:



WARNING: Indicates a potentially dangerous condition. Be careful when performing related operations.



CAUTION: Indicates a critical procedure for safe and proper operation of the controller.



NOTE: Indicates a procedure or function that is important to the safe and proper operation of the controller.

Safety Information

- Read all of the instructions and cautions in the manual before installation.
- There are no user serviceable parts inside the MPPT. Do not disassemble or attempt to repair the controller



WARNING: *Risk Of Electrical Shock. NO POWER OR ACCESSORY TERMINALS ARE ELECTRICALLY ISOLATED FROM DC INPUT, AND MAY BE ENERGIZED WITH HAZARDOUS SOLAR VOLTAGE. UNDER CERTAIN FAULT CONDITIONS, BATTERY COULD BECOME OVER-CHARGED. TEST BETWEEN ALL TERMINALS AND GROUND BEFORE TOUCHING.*

- External solar and battery disconnects are required.
- Disconnect all sources of power to the controller before installing or adjusting the MPPT.

Installation Safety Precautions



WARNING: *This unit does not contain GFDI device.*



WARNING: *The MPPT negative power terminals are common, and must be grounded as instructions, local codes, and regulations require.*

- Install the MPPT in a location that prevents casual contact. The MPPT heatsink can become very hot during operation.
- Use insulated tools when working with batteries.
- Avoid wearing jewelry during installation.
- The battery bank must be comprised of batteries of same type, make, and age.
- Do not smoke near the battery bank.
- Power connections must remain tight to avoid excessive heating from a loose connection.
- Use properly sized conductors and circuit interrupters.
- The grounding terminal is located at the bottom of the case.



WARNING: *The MPPT controller must be installed by a qualified technician in accordance with the electrical regulations of the country of installation.*



WARNING: *Pay attention to the label of the power line when installing the wiring. Avoid damaging the controller by connecting the wrong line.*



WARNING: *A means of disconnecting all power supply poles must be provided. These disconnects must be incorporated in the fixed wiring.*

A permanent, reliable earth ground must be established with connection to the MPPT ground terminal.

The grounding conductor must be secured against any accidental detachment.

Battery Safety



WARNING: A battery can present a risk of electrical shock or burn from large amounts of short-circuit current, fire, or explosion from vented gases. Observe proper precautions.



WARNING: Risk of Explosion. Proper disposal of batteries is required. Do not dispose of batteries in fire. Refer to local regulations or codes for requirements.



CAUTION: When replacing batteries, use properly specified number, sizes, types, and ratings based on application and system design.



CAUTION: Do not open or mutilate batteries. Released electrolyte is harmful to skin, and may be toxic.

- Servicing of batteries should be performed, or supervised, by personnel knowledgeable about batteries, and the proper safety precautions.
- Be very careful when working with large lead-acid batteries. Wear eye protection and have fresh water available in case there is contact with the battery acid.
- Remove watches, rings, jewelry and other metal objects before working with batteries.
- Wear rubber gloves and boots.
- Use tools with insulated handles and avoid placing tools or metal objects on top of batteries.
- Disconnect charging source prior to connecting or disconnecting battery terminals.
- Determine if battery is inadvertently grounded. If so, remove the source of contact with ground. Contact with any part of a grounded battery can result in electrical shock. The likelihood of such a shock can be reduced if battery grounds are removed during installation and maintenance (applicable to equipment and remote battery supplies not having a grounded supply circuit).
- Carefully read the battery manufacturer's instructions before installing / connecting to, or removing batteries from, the MPPT.
- Be very careful not to short circuit the cables connected to the battery.
- Have someone nearby to assist in case of an accident.
- Explosive battery gases can be present during charging. Be certain there is enough ventilation to release the gases.
- Never smoke in the battery area.
- If battery acid comes into contact with the skin, wash with soap and water. If the acid contacts the eye, flood with fresh water and get medical attention.
- Be sure the battery electrolyte level is correct before starting charging. Do not attempt to charge a frozen battery.
- Recycle the battery when it is replaced.

2.0 GENERAL INFORMATION

2.1 Features

The features of the MPPT are shown in below. An explanation of each feature is provided.

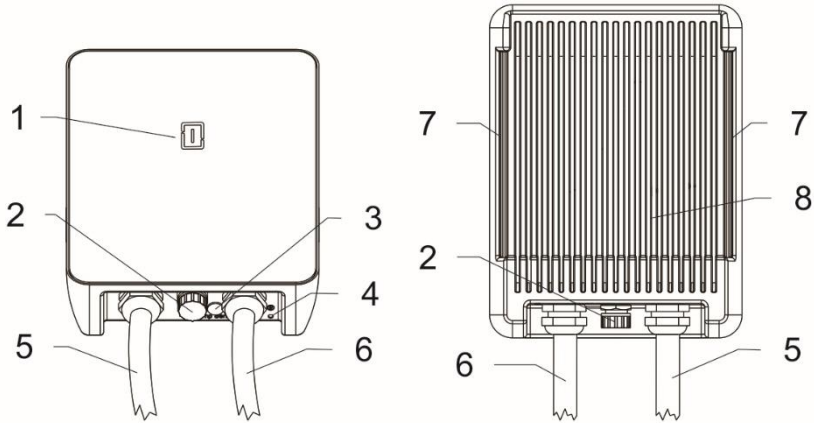

- 1 – Status indicator
- 2 – RJ45 serial communication ports
- 3 – Temperature sensor terminals
- 4 – Dedicated for grounding wire
- 5 – Input terminals (Red: PV+. Blue: PV-)
- 6 – Output terminals (Red: BAT+. Blue: BAT-)
- 7 – Mounting holes for fixed fittings

2.2 Attached Accessories

- 1 – Mounting accessories
- 2 – Temperature sensing cable
- 3 – Waterproof communication joint
- 4 – Plastic expansion particles
- 5 – M4 screws
- 6 – User manual

2.3 Optional Accessories

The following accessories are available for purchase separately from your authorized dealer:

MH-M80(Meter)

The digital Remote Meter displays system operating information, error indications. Information is displayed on an OLED display. Additionally, 3 status LEDs provide system status at a glance. The Meter can easily set the parameters of the controller. The meter can be flush mounted in a wall or surface mounted using the mounting frame (included). The **MH-M80** is supplied with 3.3 ft (1.0 m) of cable (Can be extended), a mounting frame, and mounting screws. The **MH-M80** connects to the RJ-45 port on the MPPT. The **MH-M80** cannot be used with other's outside device.

MH-S80(Meter)

The digital Remote Meter displays system operating information, error indications. Information is displayed on an OLED display. The Meter can easily set the parameters of the controller. The Meter can be connected to 4 controllers at most, and the controllers of the same battery system can work in parallel. The meter can be flush mounted in a wall or surface mounted using the mounting frame (included). The **MH-S80** is supplied with 3.3 ft (1.0 m) of cable (Can be extended), a mounting frame, and mounting screws. The **MH-S80** connects to the RJ-45 port on the MPPT. The **MH-S80** cannot be used with other's outside device.

USB-RS485 Cable

The USB-RS485 cable converts the RJ45 electrical interface to a standard USB interface which enables communication between the MPPT and a personal computer (PC). The cable can be used for programming custom charging set points, and for logging data in SolarMate. The cable cannot be used with other's outside device.

Cloud-Box-M2

A modular wiring box that can be added to MPPT controller. The box acts as a transmitter (Cloud remote control), users can use the mobile APP to control the MPPT through internet. The wire box cannot be used with other's outside device.

3.0 INSTALLATION INSTRUCTIONS

3.1 General Installation Notes

- Read through the entire installation section first before beginning installation.
- Be very careful when working with batteries. Wear eye protection. Have fresh water available to wash and clean any contact with battery acid.
- Use insulated tools and avoid placing metal objects near the batteries.



WARNING: *Never install the MPPT in an enclosure with vented/flooded batteries. Battery fumes are flammable and will corrode and destroy the MPPT circuits.*



CAUTION: *When installing the MPPT in an enclosure, ensure sufficient ventilation. Installation in a sealed enclosure will lead to over-heating, reduced power operation and a decreased product lifetime.*

- Loose power connections and /or corroded wires may result in resistive connections that melt wire insulation, burn surrounding materials, or even cause fire. Ensure tight connections and use cable clamps to secure cables and prevent them from swaying in mobile applications.
- Preset charging profiles are generally designed for common batteries. Custom settings can be used for varied charging requirements (see sections 4.2 for details).
- The MPPT battery connection may be wired to one battery, or a bank of batteries.
- The MPPT prevents reverse current leakage at night, so a blocking diode is not required in the system.
- The MPPT is designed to regulate ONLY solar (photovoltaic) power. Connection to any other type of power source e. g. wind turbine or generator may void the warranty.



WARNING: *Solar and battery fuses or DC breakers are required in the system.*

These protection devices are external to the MPPT controller.



WARNING: *Installation must comply with Electrical Code requirements. Breakers and fuses may be selected with proper specifications based on application requirements..*

3.2 Mounting

Inspect the controller for shipping damage. Do not install directly over an easily combustible surface since the heat sink may get hot under certain operating conditions.

For proper air flow, allow at least 15 cm (6 in) of space above and below the controller, and 10 cm (4 in) at the sides. Do not locate in an enclosure where battery gases can accumulate.

 **NOTE:** The heat sink must be in a vertical position (fins up and down).

STEP 1: Check the controller parameter limits

Verify that the highest temperature compensated solar array open-circuit voltage (V_{oc}) do not exceed the ratings of the MPPT version being installed. Multiple controllers can be installed in parallel on the same battery bank to achieve greater total charging current. In this type of system, each MPPT must have its own solar array.

STEP 2: Fasten the installation accessories

Align the installation accessories with the mounting holes on the controller.

Fasten the installation accessories to the controller with M4 (4-M4 stainless steel screws are included)

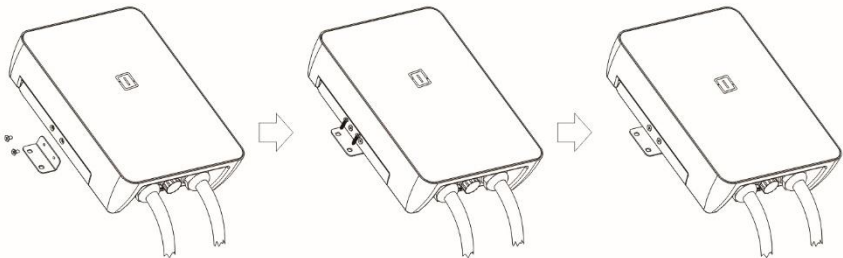

STEP 3: Drill mounting holes in the wall

Measure and mark the distance on the wall, drill two 6mm diameter holes, and fill the two holes with plastic expansion pellets.

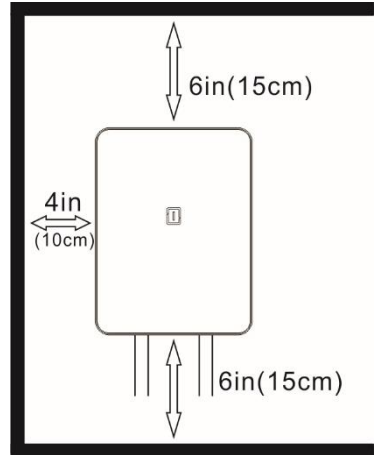

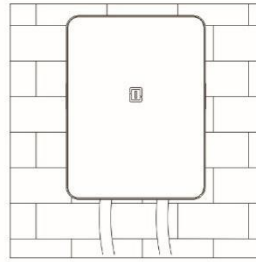
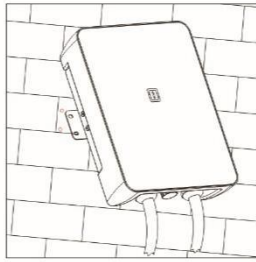
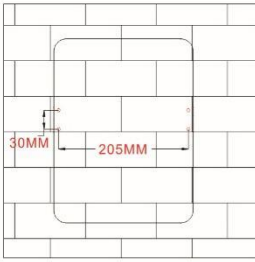

STEP 4: Mount the controller on the wall

Align the fixing holes of the controller with the mounting holes made in Step 3. Secure the controller to the mounting wall using M4 or M5 tapping screws and tighten the screws.

STEP 5: Connect input and output wires

Before wiring, it is necessary to open the cover plate on the back of the controller, then wiring according to the wire sequence and tighten the screws, and then install the cover plate again after confirmation.

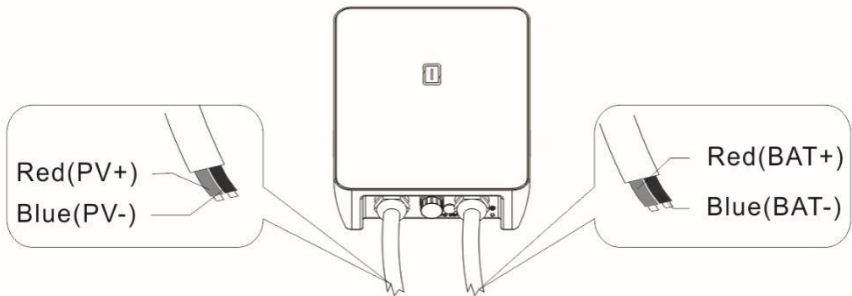

Warning: Avoid connecting the photovoltaic input to the output power line of the controller by mistake during wiring, otherwise the internal circuit of the controller may be damaged and the warranty will be invalid.

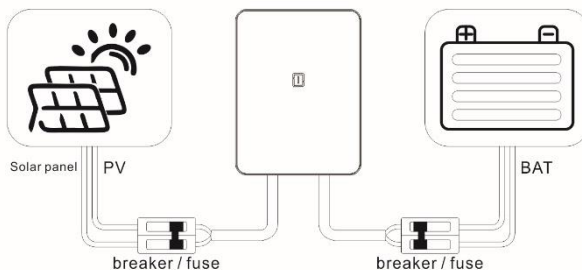

STEP 6: Power on and start working

Check that the solar panel and battery are in normal state. Check that the input and output cables are connected correctly. Then power on the battery and then the solar panel in sequence.



NOTE: Before connecting the battery, measure the open-circuit voltage. It must be over 10 volts to start the controller. If the system voltage is set to automatic detection, for example, battery voltages ranging from 18V to 30V are detected as 24V nominal batteries, and the device charges the 24V batteries. 12/24/48v Automatic recognition is performed only when the device is powered on and started.



Warning: Risk of damage

Disconnect the battery from the MPPT after the solar input is disconnected as far as possible. If the battery is removed during MPPT charging, there is a certain probability that the controller will be damaged.

4.0 OPERATION

4.1 Max Power Point Tracking Technology

Power is the product of voltage and current (Volts x Amps), the following is true*:

(1) Power Into the MPPT = Power Out of the MPPT

(2) Volts In x Amps In = Volts Out x Amps Out

* assuming 100% efficiency i.e. if no losses in wiring and conversion existed.

If the solar module's V_{mp} is greater than the battery voltage, it follows that the battery current must be proportionally greater than the solar input current so that input and output power are balanced. The greater the difference between the maximum power voltage and battery voltage, the greater the current boost.

Higher solar input voltage results in lower solar input current for a given input power. High voltage solar input strings allow for smaller gauge solar wiring. This is especially helpful for systems with long wiring runs between the solar array and the MPPT.

An Advantage Over Traditional Controllers Traditional controllers connect the solar

module directly to the battery when recharging. This requires that the solar module operate in a voltage range that is below the module's V_{mp} . In a 12V system, for example, the battery voltage may range from 10 - 15 Vdc but the module's V_{mp} is typically around 17V. The figure below shows a typical current vs. voltage output curve for a nominal 12V charging system.

12 Volt Module Current vs. Voltage

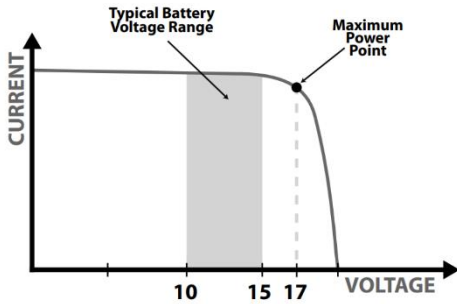

12 Volt Module Output Power

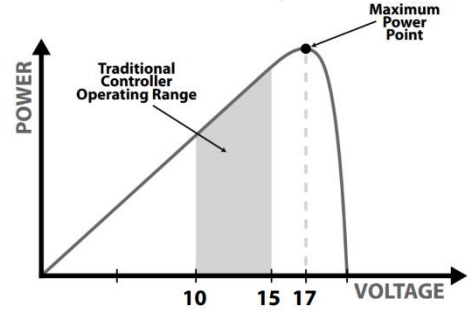

4.2 Battery Charging

Charging lead-acid batteries

The MPPT has a 4-stage battery charging algorithm for rapid, efficient, and safe battery charging.

- 1 - **CC Stage** (Constant Current Charging): Fast Charging
- 2 - **CV Stage** (Constant Voltage Charging): Absorption Charging
- 3 - **CF Stage** (Floating Charging): Protect the battery from long-term overcharge. And make up the loss of self-discharge
- 4 - **Equalization Stage**: Activate battery chemical reaction

Charging Lithium ion batteries

The MPPT will charge according to the specifications of lithium-ion battery, which is mainly divided into two stages. First stage, when the battery voltage is less than the saturation voltage, it will charge quickly, and the second stage, when the battery voltage is equal to the saturation voltage, it will absorb charge.

Battery Charge Setting

Charging parameters of lead-acid battery. All voltage settings listed are for nominal 12 Volt batteries. Multiply the voltage settings by two (2) for 24 Volt batteries. Multiply the voltage settings by four(4) for 48 Volt batteries.

Battery Charging Set-points (@ 25°C): [multiply voltages by (2) for 24 volt systems] [multiply voltages by (4) for 48 volt systems]

Bat Type	CV (volts)	CF (volts)	Equalize (volts)	Equalize (minutes)	Undervoltage Protection	Undervoltage Recovery
Gel	14.2	13.8	-	-	11.1	12.6
Sealed	14.4	13.8	14.6	30 Custom	11.1	12.6
Flooded	14.6	13.8	14.8	30 Custom	11.1	12.6
Custom	Custom	Custom	Custom	30 Custom	Custom	Custom

Recommended charging parameter setting reference value for lithium-ion batteries.

Bat Type	Nominal Voltage	Saturation Voltage	Cut-off Voltage	Cut-off Recovery
12V-LiFePO4-4s	12.8	14.4	10.8	12.4
24V-LiFePO4-8s	25.6	28.8	21.6	24.8
48V-LiFePO4-15s	48.0	54.0	40.5	46.5
12V-Ternary-3s	11.1	12.6	9.6	10.5
24V-Ternary-6s	22.2	25.2	19.2	21.0
48V-Ternary-13s	48.1	54.6	41.6	45.5
Custom	Custom	Custom	Custom	Custom



NOTE: These settings are general guidelines for use at the operator's discretion. The MPPT can be set to satisfy a wide range of charging parameters. Consult the battery manufacturer for optimal battery charge settings.

4.3 Electrical structure and function description

This series of products is a step-down solar charging controller with maximum power point tracking function.

Using high-performance DSP chip as the control core, combined with advanced MPPT control algorithm, this product has an industry-leading utilization rate of photovoltaic power generation.

The application of Synchronous Step-Down technology greatly reduces the heat loss and ensures excellent energy conversion efficiency.

The use of power semiconductor switching devices to achieve reverse polarity protection, effectively improving the reliability of products.

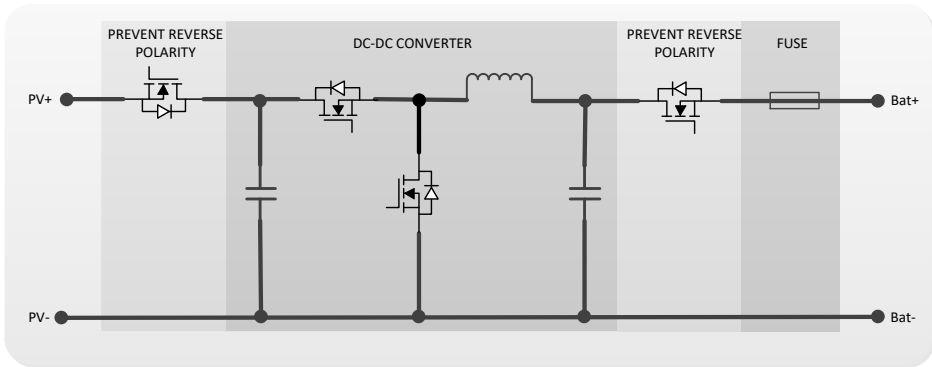

4.4 Status Indications

Yellow: in standby mode, there is no charging condition.

Bule: When the breathing light and dark changes, it indicates the fast charging state (CC), When it keeps lighting, it indicates that the battery is fully charged.

Red: There are faults or warnings.

4.5 Operation

This series of controllers adopts a screen less design, and all operations can be completed through the built-in Bluetooth module. Users can download and install apps by searching "SolarMate" in the Appstore or Googleplay, or obtain the installation package through our official website. After installation, you can use the app to interact with the controller through Bluetooth when the Bluetooth function of the mobile phone is enabled.



Note: If need to customize other parameters, you can implement them through optional accessories.

Scan the QR code below to see more video demonstrations!Youtube



5.0 TROUBLE SHOOTING



WARNING: RISK OF ELECTRICAL SHOCK.

NO POWER OR ACCESSORY TERMINALS ARE ELECTRICALLY ISOLATED FROM DC INPUT, AND MAY BE ENERGIZED WITH HAZARDOUS SOLAR VOLTAGE. UNDER CERTAIN FAULT CONDITIONS, BATTERY COULD BECOME OVERCHARGED. TEST BETWEEN ALL TERMINALS AND GROUND BEFORE TOUCHING.



WARNING: Shock Hazard

A means of disconnecting all power supply poles must be provided. These disconnects must be incorporated in the fixed wiring. Open all power source disconnects before removing controller wiring cover, or accessing wiring.

Problem:

No LED indications, controller does not appear to be powered

Solution:

With a multi-meter, check the voltage at the battery terminals on the MPPT. Battery voltage must be 10 vdc or greater. If the voltage on the battery terminals of the controller is between 10 and 60 vdc, and no LEDs are lit, contact your authorized dealer for service. If no voltage is measured, check wiring connections, fuses, and breakers.

Problem:

The MPPT is not charging the battery.

Solution:

Check the fuses, breakers, and wiring connections in the power source wiring. With a multi-meter, check the array voltage directly at the MPPT solar input terminals. Input voltage must be greater than battery voltage before charging will begin.

Check whether the battery voltage in App is in the range of controller system recognition.

Problem:

The battery is in a low energy or empty for a long time.

Solution:

Possible reasons: 1. The number of solar panels are too small to generate enough energy to meet the use of the system, and the solar panel array can be increased appropriately.

2. The battery capacity is too small to store enough energy for the system. The

battery string capacity can be increased.

6.0 TECHNICAL SPECIFICATIONS

Common Negative MPPT Controller		
Model:	ET4850	ET4860
Electrical:		
Nominal Battery Voltage	12 / 24 /36 / 48 Vdc	
Battery Voltage Range	9 ~ 60Vdc	
Voltage Accuracy	< +/- 0.2V	
Max.Battery Current	50A	60A
Max.PV Open-Circuit Voltage	150V	
Self-Consumption	1.2~1.8W	
Conversion Efficiency (Peak)	98%	
Mechanical:		
Dimensions (Net)	290x220x90	
Dimensions (Pack)	410x328x193	
Weight (Net)		
Weight (Pack)		
Data & Communications		
Communication Port	RJ45 / RS485	
Comm.Protocols	Private protocol and MODBUS	
PC Software	SolarMate	
Meter	MH-M80 / MH-S80	
Electrical Interface	5V current supply / rated power 1W	
Dry Contact Access Voltage	Via RJ45 port	
Environmental acclimation:		
Operating ambient temperature	-30°C ~ +50°C	
Storage Temperature	-30°C ~ +80°C	
Humidity	100% n.c.	
IP (Ingress protection)	IP65	

Protections

Anti-reverse connection protection - Reverse connection of positive and negative polarity between the battery end and the photovoltaic array end

Solar Short-Circuit

Internal overtemperature - Reduced power operation

Heatsink Temperature Limit

Over-volt / low-volt protection

Battery shedding

Wire Sizing Charts

2% Voltage Drop Charts for 75°C Stranded Copper Wire

1-Way Wire Distance (feet), 12 Volt System									
Wire Size (AWG)	60A	55A	50A	45A	40A	35A	30A	25A	20A
2/0*	22.4	24.4	26.9	29.9	33.6	38.4	44.8	53.8	67.2
1/0*	17.7	19.3	21.3	23.6	26.6	30.4	35.5	42.6	53.2
2	11.2	12.2	13.4	14.9	16.8	19.2	22.4	26.9	33.6
4	7.1	7.7	8.5	9.4	10.6	12.1	14.1	17.0	21.2
6	4.4	4.8	5.3	5.9	6.6	7.5	8.8	10.6	13.2
8	2.8	3.1	3.4	3.7	4.2	4.8	5.6	6.7	8.4
10	1.7	1.9	2.1	2.3	2.6	3.0	3.5	4.2	5.2
1-Way Wire Distance (meters), 12 Volt System									
Wire Size (mm ²)	60A	55A	50A	45A	40A	35A	30A	25A	20A
70*	6.8	7.4	8.2	9.1	10.2	11.7	13.7	16.4	20.5
50*	5.4	5.9	6.5	7.2	8.1	9.3	10.8	13.0	16.2
35*	3.4	3.7	4.1	4.5	5.1	5.8	6.8	8.2	10.2
25	2.1	2.3	2.6	2.9	3.2	3.7	4.3	5.2	6.4
16	1.3	1.5	1.6	1.8	2.0	2.3	2.7	3.2	4.0
10	0.8	0.9	1.0	1.1	1.3	1.5	1.7	2.0	2.5
6	0.5	0.6	0.6	0.8	0.8	0.9	1.1	1.3	1.6

Maximum 1-way wire distance for 12 Volt systems, stranded copper, 2% voltage drop

2% Voltage Drop Charts for 75°C Solid Copper Wire

1-Way Wire Distance (feet), 12 Volt System									
Wire Size (AWG)	60A	55A	50A	45A	40A	35A	30A	25A	20A
2/0*	27.8	30.3	33.4	37.1	41.7	47.7	55.6	66.7	83.4
1/0*	22.1	24.1	26.5	29.4	33.1	37.8	44.1	53.0	66.2
2	13.9	15.1	16.6	18.5	20.8	23.8	27.7	33.3	41.6
4	8.7	9.5	10.5	11.6	13.1	15.0	17.5	21.0	26.2
6	5.5	6.0	6.6	7.3	8.2	9.4	10.9	13.1	16.4
8	3.5	3.8	4.2	4.6	5.2	5.9	6.9	8.3	10.4
10	2.2	2.4	2.6	2.9	3.3	3.8	4.4	5.3	6.6
1-Way Wire Distance (meters), 12 Volt System									
Wire Size (mm ²)	60A	55A	50A	45A	40A	35A	30A	25A	20A
70*	8.5	9.2	10.2	11.3	12.7	14.5	16.9	20.3	25.4
50*	6.7	7.3	8.1	9.0	10.1	11.5	13.4	16.1	20.2
35*	4.2	4.6	5.1	5.6	6.3	7.2	8.5	10.1	12.7
25	2.7	2.9	3.2	3.5	4.0	4.6	5.3	6.4	8.0
16	1.7	1.8	2.0	2.2	2.5	2.9	3.3	4.0	5.0
10	1.1	1.1	1.3	1.4	1.6	1.8	2.1	2.5	3.2
6	0.7	0.7	0.8	0.9	1.0	1.1	1.3	1.6	2.0

Maximum 1-way wire distance for 12 Volt systems, solid copper, 2% voltage drop



Note: *Wires sizes larger than 4 AWG (25 mm²) must be terminated at a splicer block located outside of the MPPT. Use 4 AWG (25 mm²) or smaller wire to connect to the MPPT to the splicer block.



• The specified wire length is for a pair of conductors from the solar or battery source to the controller (1-way distance)

- For 24 volt systems, multiply the 1-way length in the table by 2.
- For 48 volt systems, multiply the 1-way length in the table by 4.

RJ45 Port Definition

PIN	Function
1	RS485-A
2	RS485-B
3	Dry contact
4	Dry contact
5	GND(isolation)
6	GND(isolation)
7	+5V(isolation)
8	+5V(isolation)

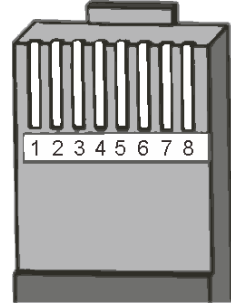

(Note: The pin definition is only applicable to our related products!)

Serial Connection(String) Of Solar Panels

Voc * N = PVininput < 150Vdc												
System Voltage	Voc<23V		Voc<31V		Voc<34V		Voc<38V		Voc<46V		Voc<62V	
	Max.	Best	Max.	Best	Max.	Best	Max.	Best	Max.	Best	Max.	Best
12V	6	2	4	1	4	1	3	1	3	1	2	1
24V	6	3	4	2	4	2	3	2	3	2	2	1
36V	6	4	4	3	4	3	3	3	3	2	2	1
48V	6	5	4	4	4	3	3	3	3	2	2	2



Note: The table is the quantity(N) of solar panels in series, for reference only.

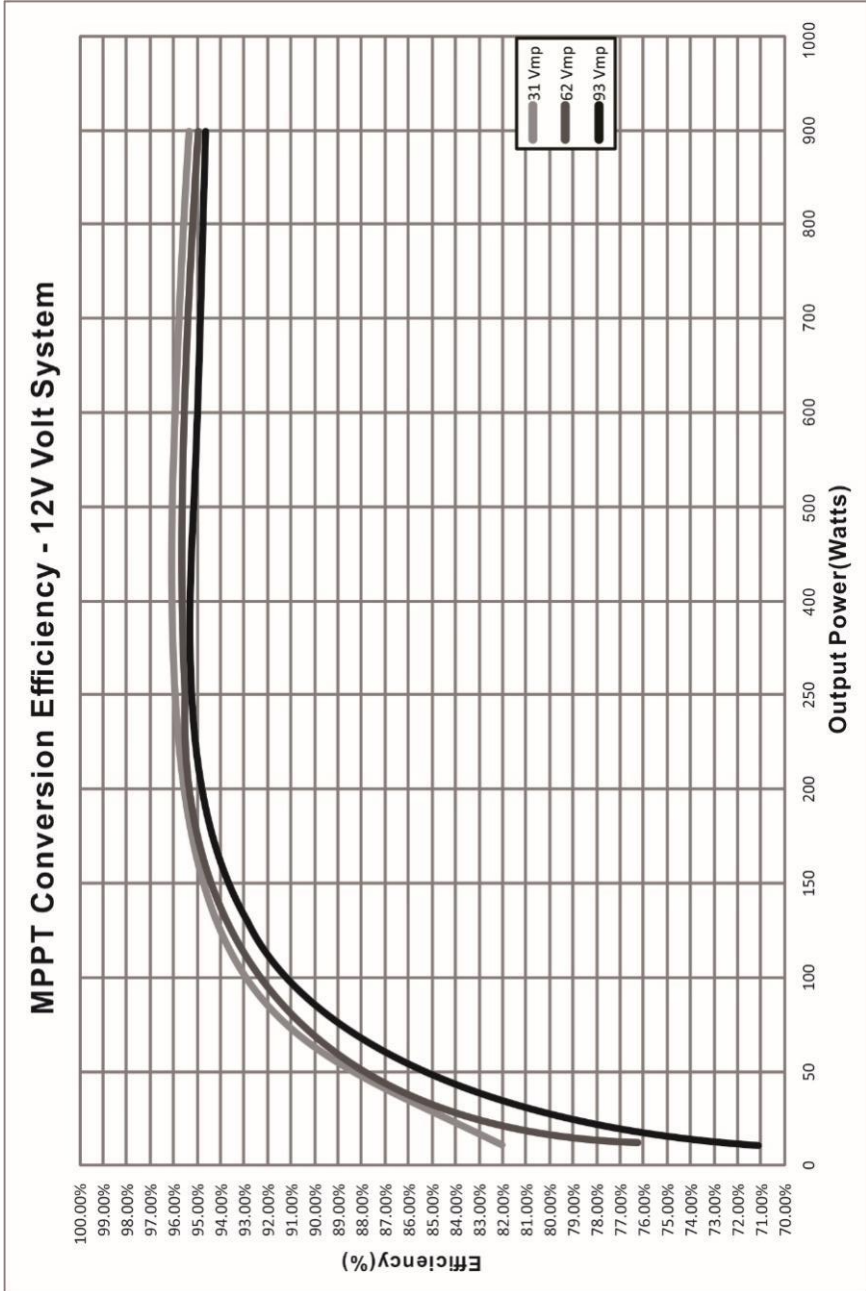

MPPT Conversion Efficiency - 24V Volt System

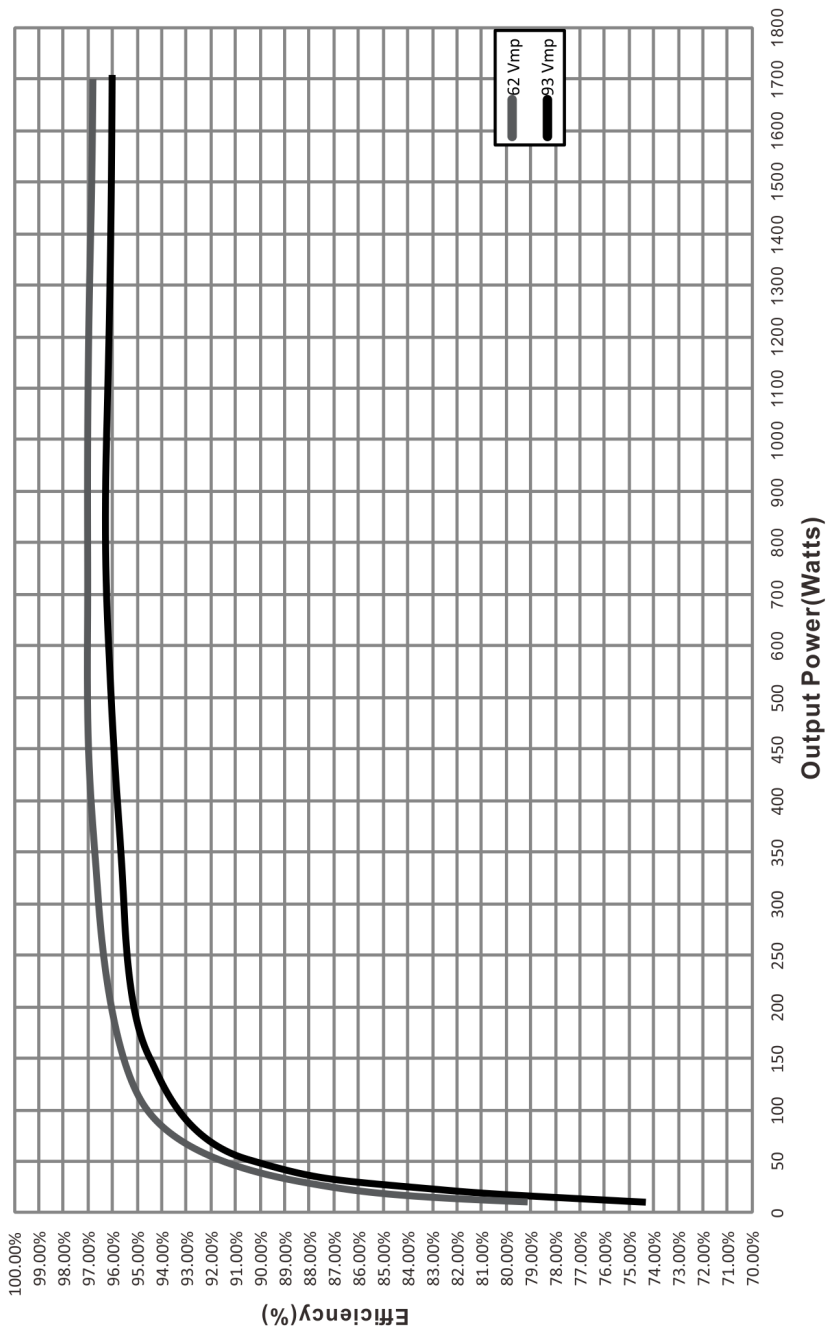

MPPT Conversion Efficiency - 48V Volt System

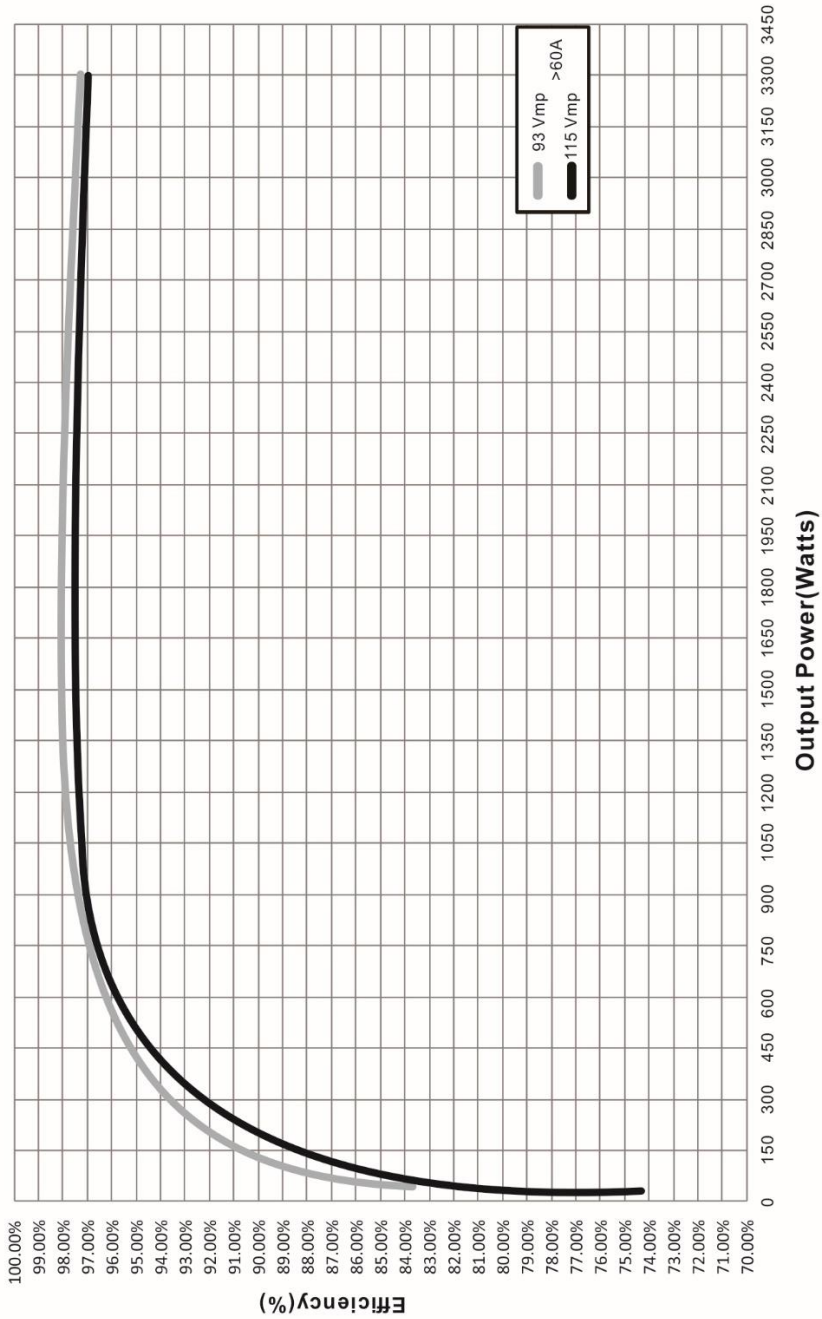

IPANDEE

Acid Li

EXPLORER-T

Solar Charging System Controller

SHENZHEN • CHINA

 www.ipandee.com

 service@ipandee.com